

yuwell

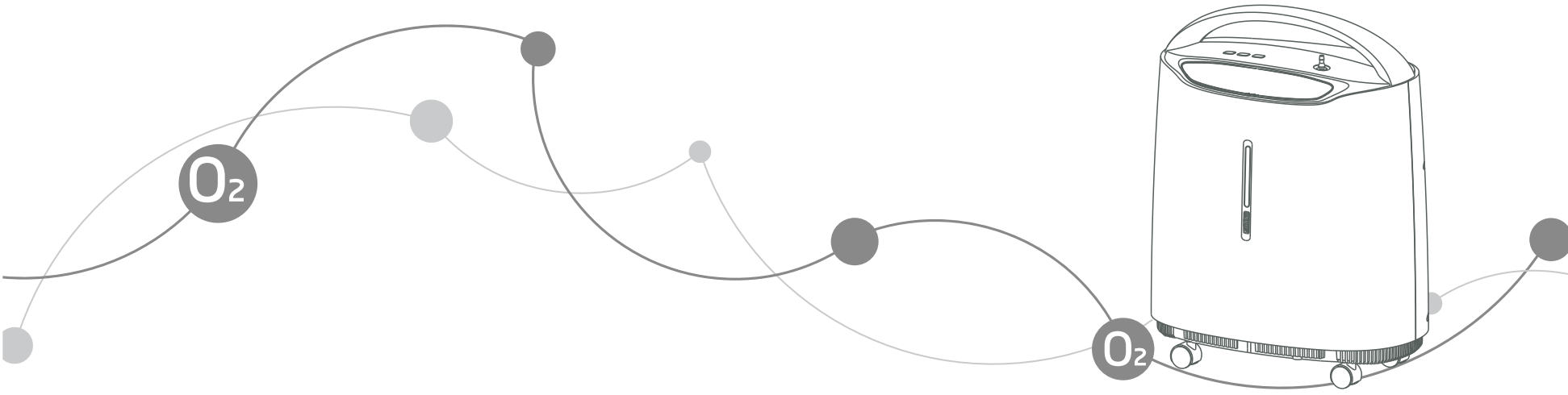

JIANGSU YUYUE MEDICAL EQUIPMENT & SUPPLY CO., LTD.
No.1 Baisheng Road Development Zone, Danyang, Jiangsu 212300 CHINA
TEL: 86-511-86900833
www.yuwell.com

yuwell

Document No. : YY-OXG8510D-02(A/2)
Revision Date: 2024.02

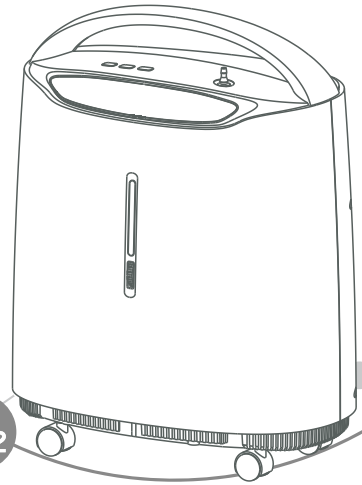

8F-5A Oxygen Concentrator

User's Manual

Do not operate this unit without first
reading and understanding this manual

SAFETY NOTES

TABLE OF CONTENTS

SAFETY NOTES	01-08
FEATURES	09-12
HANDLING	13-13
OPERATING & INSTALLATION	14-25
MAINTENANCE	26-29
TROUBLESHOOTING	30-32
OTHER ATTENTION ITEMS	33-34
EMC INFORMATION	35-38

INTENDED USE

INDICATIONS: This oxygen concentrator is intended for using as an oxygen supplement device in the professional healthcare facility and home healthcare environment. It provides high concentration of oxygen to persons requiring oxygen therapy. This device is to be used as an oxygen supplement and is NOT considered life-supporting or life-sustaining.

CONTRA-INDICATIONS: There are no known contra-indications.

PATIENT TARGET GROUP OR GROUPS: Adults only.

INTENDED USERS: Healthcare professional or lay person, patient is also the intended operator.

SIDE EFFECT: No side effect.

⚠ WARNING: U.S. Federal law restricts this device to sale by or on the order of a physician.

Symbol	Description
⚠ WARNING	Describes a hazard or unsafe practice that if not avoided can result in severe bodily injury, death or property damage.
⚠ CAUTION	Describes a hazard or unsafe practice that if not avoided can result in minor bodily injury or property damage.

I . IMPORTANT MESSAGE

- To reduce the risk of electrical shock, do not disassemble the oxygen concentrator. Ask qualified service personnel to perform repairs.
- Before operating the oxygen concentrator, read and understand this manual.
- Use the oxygen concentrator for only intended use as described in this manual.
- If the performance of the oxygen concentrator is changed, contact qualified service personnel for technical support.

SAFETY NOTES

II . BEFORE INSTALLATION

- ▶ The oxygen concentrator should always be kept upright to prevent damage while being transported.
- ▶ If the electrical source power voltage is unstable that beyond normal voltage rang, please add the voltage stabilizer.
- ▶ Please use eligible, safe power set and junction box.
- ▶ Non-professionals do not dismantle the housing of the oxygen concentrator. Removing the oxygen concentrator or replacing the internal components will may cause injury to personnel or damage to the device.

III . PLACE

- ▶ You may select a room in your house where using your oxygen concentrator would be most convenient. Oxygen concentrator can easily move from one room to other room by the casters.
- ▶ Be certain to place the device so all sides are at least 10 cm (4 inches) away from walls, draperies, furniture, or other obstruction. The air intake as well as the exhaust of the oxygen concentrator should be located in a well-ventilated area.
- ▶ Oxygen concentrator should be located so as to avoid pollutants or fumes.
- ▶ Oxygen concentrator must avoid heat source, fire source, wetness, and environments with excessively high or low temperatures.
- ▶ Sundries and vessel do not be placed on top of the oxygen concentrator.
- ▶ Always place the oxygen concentrator in a position where the operator can hear the audio alarming.
- ▶ Do not use oxygen concentrator in MRI (magnetic resonance imaging) environment.

SAFETY NOTES

IV . USING

- ⚠ **WARNING:** To ensure receiving the therapeutic amount of oxygen delivery according to your medical condition 8F-5A oxygen concentrator must:
 - be used with settings that have been individually determined or prescribed for you at your activity levels with your accessories;
 - be used with the specific combination of parts and accessories that are in line with the specification of the concentrator or accessory manufacturer.
- ⚠ **WARNING:** Use of this device at an altitude above 2000 m or outside a temperature of 5°C~40°C or a relative humidity above 90% is expected to adversely affect the flowrate and the percentage of oxygen and consequently the quality of the therapy.
- ▶ The oxygen delivery settings of the oxygen concentrator should be periodically reassessed for the effectiveness of the therapy.
- ▶ The oxygen delivery setting has to be determined for each patient individually with the configuration of the equipment to be used, including accessories.
- ▶ No lubricants other than those recommended by the manufacturer are to be used.
- ▶ Do not use parts, accessories or adapters other than those authorized by manufacturer.
- ▶ Do not connect the oxygen concentrator in parallel or series with other oxygen concentrators or oxygen therapy devices.
- ▶ Avoid using while bathing. If continuous usage is required by the physician's prescription, the oxygen concentrator must be located in another room at least 2.5 m from the bath.
- ▶ Oxygen concentrator is to be used only in accordance with the prescription of a physician and this User's Manual. If at any time the patient or attendant concludes that the patient is receiving an insufficient amount of oxygen, the supplier and/or physician should be contacted immediately. No

SAFETY NOTES

adjustments should be made to the flowrate unless prescribed by a physician.

- It takes 15 minutes from switching on the oxygen concentrator until it can be relied upon to deliver the set flowrate and concentration of oxygen.
- For optimum performance, do not open or turn off the oxygen concentrator frequently, reset after 3 ~ 5 minutes. Shorter periods of operation may reduce maximum product life.
- The service life of 8 hours per day is 3 years.

V. MAINTENANCE

- The oxygen concentrator was specifically designed to minimize routine preventive maintenance at intervals of once per year. Only professionals of the healthcare field or persons fully conversant with this process such as authorized or factory trained personnel should perform preventive maintenance or performance adjustments on the oxygen concentrator.

⚠ WARNING: Against servicing and maintenance while the oxygen concentrator is in use.

- The manufacturer will make available on request circuit diagrams, component part lists, descriptions, calibration instructions, or other information that will assist service personnel to repair those parts of oxygen concentrator that are designated by the manufacturer as repairable by service personnel.

VI. RADIO FREQUENCY INTERFERENCE

- This equipment has been tested and found to comply with EMC limits specified by IEC 60601-1-2. These limits are designed to provide a reasonable protection against electromagnetic interference in a typical medical installation.
- Other devices may experience interference from even the low levels of electromagnetic emissions permitted by the above standards.

SAFETY NOTES

- To determine if the emissions from the concentrator are causing the interference, turn the concentrator off. If the interference with the other device(s) stops, then the concentrator is causing the interference. In such rare cases, interference may be reduced or corrected by one of the following measures:
 - Reposition, relocate, or increase the separation between the equipment.
 - Connect the equipment into an outlet on a circuit different from that to which the other device(s) is connected.
 - Consult the manufacturer or service personnel for help.

VII. TO REDUCE THE RISK OF BURNS, ELECTROCUTION, FIRE OR INJURY TO PERSONS

⚠ WARNING: There is a risk of fire associated with oxygen enrichment during oxygen therapy. Do not use the oxygen concentrator or accessories near sparks or open flames.

⚠ WARNING: Use only water-based lotions or salves that are oxygen-compatible before and during oxygen therapy. Never use petroleum-based or oil-based lotions or salves to avoid the risk of fire and burns.

⚠ WARNING: Do not lubricate fittings, connections, tubing, or other accessories of the oxygen concentrator to avoid the risk of fire and burns.

⚠ WARNING: Use only spare parts recommended by the manufacturer to ensure proper function and to avoid the risk of fire and burns.

⚠ WARNING: Oxygen makes it easier for a fire to start and spread. Do not leave the nasal cannula or mask on bed coverings or chair cushions, if the oxygen concentrator is turned on, but not in use; the oxygen will make the materials more flammable. Turn the oxygen concentrator off when not in use to prevent oxygen enrichment.

⚠ WARNING: Smoking during oxygen therapy is dangerous and is likely to result in facial burns or death. Do not allow smoking or open flames within the same room as the oxygen concentrator or any oxygen-carrying

SAFETY NOTES

accessories. If you smoke, you must always turn the oxygen concentrator off, remove the cannula and leave the room where either the cannula or mask or the oxygen concentrator is located. If unable to leave the room, you must wait 10 minutes after you have turned the oxygen concentrator off.

- ⚠ **WARNING:** Open flames during oxygen therapy are dangerous and are likely to result in fire or death. Do not allow open flames within 2 m of the oxygen concentrator or any oxygen-carrying accessories.
- The use of oxygen therapy requires that special care be taken to reduce the risk of fire. Users must not smoke while using this device. Keep all matches, lighted cigarettes or other sources of ignition out of the room in which this product is located. No smoking signs should be prominently displayed. Textiles and other materials that normally would not burn are easily ignited and burn with great intensity in oxygen enriched air. Failure to observe this warning can result in severe fire, property damage and cause physical injury or death.
- A spontaneous and violent ignition may occur if oil, grease or greasy substances come in contact with oxygen under pressure. These substances must be kept away from the oxygen concentrator, tubing and connections, and all other oxygen device.
- Avoid creation of any spark near oxygen concentrator. This includes sparks from static electricity created by any type of friction.
- ⚠ **WARNING:** If you feel discomfort or are experiencing a medical emergency while undergoing oxygen therapy, seek medical assistance immediately to avoid harm.
- ⚠ **WARNING:** Geriatric, paediatric or any other patient unable to communicate discomfort can require additional monitoring to convey the information about the discomfort and or the medical urgency to the responsible care giver to avoid harm.
- Close supervision is necessary when the oxygen concentrator is used near children or physically-challenged individuals.

SAFETY NOTES

- Be aware that the power supply cord and nasal cannula could present a tripping or strangulation hazard. Always place the power supply cord and nasal cannula in a manner that prevents crushing by casters or others.
- Please pay attention to prevent choking resulting from a child swallowing a small part that has become detached from the oxygen concentrator.
- Do not come in contact with the oxygen concentrator while wet.
- Do not place or store oxygen concentrator where it can drop into water or other liquid.
- Do not reach for oxygen concentrator that has fallen into water. Cut off the power immediately.
- Oxygen concentrator should never be left unattended when plugged in.
- ⚠ **WARNING:** Do not modify the oxygen concentrator in any way. Modifications could result in hazards to the user.
- This oxygen concentrator and accessories do not contain natural rubber latex.
- This oxygen concentrator and accessories do not contain phthalates.
- Prolonged contact with applied parts or other accessories does not cause skin irritation.
- Do not move the oxygen concentrator while it is powered on.
- In certain circumstances oxygen therapy can be hazardous. Manufacturer recommends that you seek medical advice before using this product.
- To reduce the risk of infecting another user or operator of reuse the oxygen concentrator, the cabinet should be cleaned by a mild household cleaner before reuse. And all external tubing, cannula or other accessory should be replaced.
- The distributor or the responsible person should instruct the operator to assess the needs of the patient for backup supplies of supplementary oxygen in case of oxygen concentrator or power failure:

SAFETY NOTES

a) at installation based on

- the condition of the patient,
- the environment in which the patient lives, and
- the ability to resupply the patient with backup supplies of supplementary oxygen; and

b) periodically as these attributes change.

- Lay operator or lay responsible organization should contact the manufacturer or the manufacturer's representative:
 - for assistance, if needed, in setting up, using or maintaining the me equipment; or
 - to report unexpected operation or events.
- Over temperature alarm of the oxygen concentrator can be a means to reduce the extent of the propagation of fire if ignition occurs.
- All parts of this oxygen concentrator are suitable for use within the patient environment.
- Lint, dust, pet hair, pests may cause blockage of the air intake and exhaust of the oxygen concentrator, please check and clean it regularly.
- Heat from a fireplace or radiant heater may accelerate the aging of the oxygen concentrator's internal components.
- Moisture from a nebuliser or steam kettle may accelerate the aging of molecular sieves in oxygen concentrator.
- Take care to prevent children from adjusting the settings of the oxygen concentrator.

FEATURES

I . SUMMARY

- This user's manual will tell you about your concentrator and will serve as a reference as you use your concentrator.

▸ USE SPECIFICATION

INTENDED MEDICAL INDICATION: This oxygen concentrator is intended for using as an oxygen supplement device in the professional healthcare facility and home healthcare environment. It provides high concentration of oxygen to persons requiring oxygen therapy.

INTENDED PATIENT POPULATION: Adults only.

INTENDED PART OF THE BODY OR TYPE OF TISSUE APPLIED TO OR INTERACTED WITH: During oxygen inhalation, the nasal oxygen cannula is in direct contact with the user's facial skin and nasal cavity.

INTENDED USER PROFILE: Healthcare professional or lay person, patient is also the intended operator.

USE ENVIRONMENT: Hospital use or home use.

OPERATING PRINCIPLE: The oxygen concentrator, whose material is air, uses molecular sieve as adsorbent to produce oxygen by Pressure Swing Adsorption.

II . CHARACTERS

- Complete plastic housing, safe and reliable.
- Time accumulation function, show total hours through the display screen.
- Timing turns off function.
- Compressor pressure relief valve help the device safer.
- Power supply failure and power loss alarm function.
- Device failure alarm function (including pressure failure, compressor failure, low oxygen concentration, low oxygen flowrate, over temperature).
- Compressor with over heat protect function to gain in safety of the compressor and the oxygen concentrator.

FEATURES

- ▶ Remote control function.

III. SPECIFICATIONS

1. Power Supply: 120V ~ , 60Hz
2. Input Power: 350VA
3. Maximum Recommend Flow Rate: 5 L/min
4. Oxygen Concentration at Nominal Output Pressure of 0kPa (Measured after warm up 15 minutes) : 5 L/min: 87%~96%
5. Maximum limited pressure: 70kPa
6. Sound Pressure Level (when measured at 1 m from front of device): 48dB(A) typical.
Note: (Maximum Sound Pressure Level is 52dB(A) and Maximum Sound Power Level is 60dB(A) at 3 L/min and 5 L/min with an uncertainty of 2dB(A); Measured according to noise test method given in ISO 80601-2-69 using the basic standard ISO 3744.)
7. Audio Alarm:
48dB(A) or greater when failure alarm;
40dB(A) or greater when power lost.
8. The rated range of both the oxygen delivery flowrate and the concentration of oxygen as a function of flowrate:
 - Tested at STPD (101.3kPa, 20°C, dry) conditions and rated operating condition specified in the manual. (Figure 1)
 - Oxygen concentration may be affected by over the rated ranges of ambient temperature, humidity and atmospheric pressure.
 - The measurement uncertainty of Flowrate is $\pm 10\%$.
 - The measurement uncertainty of Oxygen Concentration is $\pm 3\%$.
9. Altitude: Not higher than 2000 meters above sea level.
10. Net Weight: 15.5kg
Dimension: 39.0 × 24.5 × 50.0 (cm)

FEATURES

Flowrate	Oxygen Concentration
1L/min	87%~96%
2L/min	87%~96%
3L/min	87%~96%
4L/min	87%~96%
5L/min	87%~96%

Figure 1

11. Work system: work continuously
12. Minimum Operating Time: 15 minutes
13. Electric classification: class II equipment, type BF applied part, IP21
Applied part: Nasal Cannula
14. Electric classification:
over voltage category: II pollution degree: 2 altitude: $\leq 2000\text{m}$
15. Safety System:
 - Power supply failure: Alarming
 - Power loss alarm: Alarming and Shut Down
 - Pressure failure: Alarming and Shut Down
 - Compressor failure: Alarming and Shut Down
 - Low oxygen concentration(70%~82%): Alarming
 - Low oxygen concentration(< 70%): Alarming
 - Low flow alarm: Alarming and Shut Down
 - Over temperature alarm: Alarming and Shut Down
16. Normal Operating Condition (with Oxygen Concentration Status Indicator):
 - Temperature range: 5°C ~ 40°C
 - Relative humidity: 15% ~ 90%, Non-condensing.
 - Atmosphere pressure: 86kPa ~ 106kPa

FEATURES

⚠ CAUTION: When operating condition over the rated ranges of ambient temperature, humidity and atmosphere pressure, the performance of the oxygen may be dropped.

17. Oxygen Output Temperature: $\leq 46^{\circ}\text{C}$

Applied part Temperature (Nasal Cannula): $\leq 41^{\circ}\text{C}$

18. Cannula length DO NOT more than 15.2m and no twist.

19. Storage and Transportation Condition:

- Temperature range: $-20^{\circ}\text{C} \sim 60^{\circ}\text{C}$
- Relative humidity: 10%~93%, Non-condensing.
- Atmosphere pressure: 70kPa ~ 106kPa

⚠ CAUTION: The device should be stored with no strong sunlight, no corrosive gas and well ventilated indoor area. The device must be transported and used in the vertical position only.

⚠ CAUTION: It takes 4 hours for the oxygen concentrator to cool from the minimum/maximum storage temperature between uses until the oxygen concentrator is ready for its intended use when the ambient temperature is 20°C .

HANDLING

I . UNPACKING

⚠ CAUTION: Unless use the oxygen concentrator, retain containers and packing materials for storage until use of the concentrator is required.

1. Check for any obvious damage to the carton or other packaging. If damage is evident, please notify the carrier or local dealer.
2. Remove all loose packaging from the carton.
3. Carefully remove all the components from the carton.

II . INSPECTION

1. Examine exterior of the oxygen concentrator for nicks, dents, scratches or other damages.
2. Inspect all components.

III . STORAGE

1. Store the repackaged oxygen concentrator in a dry area.
2. Do not place other objects on top of the oxygen concentrator.

OPERATING & INSTALLATION

I . FEATURE VIEW

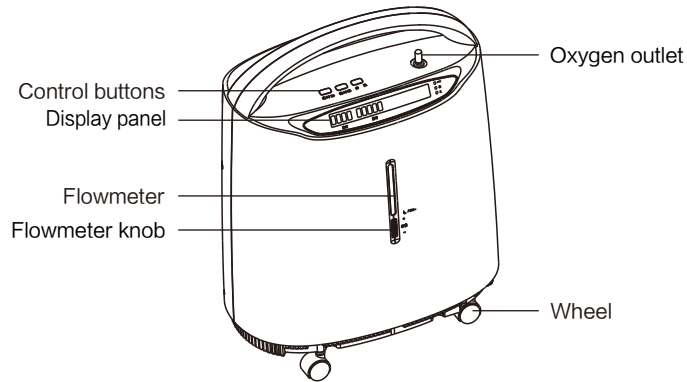

Figure 2: Front View

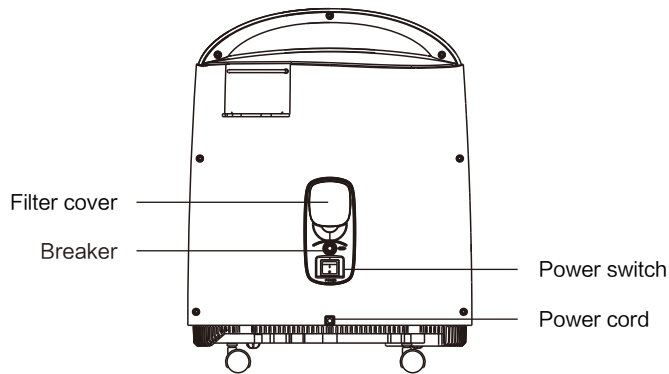

Figure 3: Rear View

OPERATING & INSTALLATION

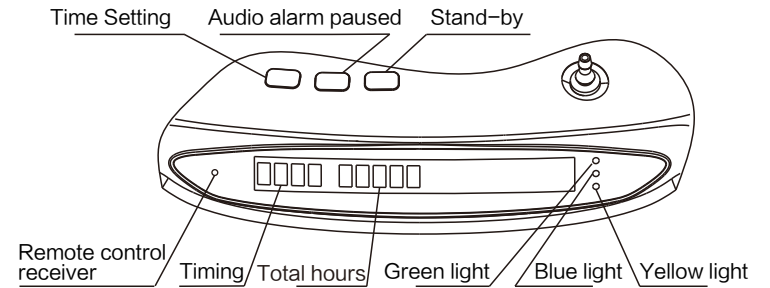

Figure 4: Control panel

II . PREPARE WORK

NOTE: Inspect the power cord/plug and the exterior of the oxygen concentrator for nicks, dents, scratches or other damages before usage. If it is necessary, call qualified service personnel for examination and repair.

1. Connect the power supply.
2. If you want to move the oxygen concentrator, unlock the locks on the four casters. (Figure 5)



unlock the lock to move

push down the lock to fix

Figure 5: Caster

OPERATING & INSTALLATION

⚠ CAUTION:

- 1) The power supply cord of the oxygen concentrator is not removable. If the power supply cord is damaged, contact the service personnel to replace it.
- 2) Keep the power supply cord away from heated surfaces.
- 3) Do not move or relocate the oxygen concentrator by pulling on the power supply cord.
- 4) Do not use extension cords with this unit.

NOTE: Oxygen concentrator may be used during the initial start warm-up time (approximately 15 minutes) while waiting for the oxygen concentration to reach maximum.

III . OXYGEN ABSORBING OPERATION

▸ TURN ON

When pressing the power switch to " | " position, "HELLO" will be shown on the display screen, and the blue, green and yellow indicators will be turned on at the same time, indicating that the oxygen concentrator is functioned properly. A few seconds later, only the green indicator will be on, and the display screen show the timing and total hours, then the oxygen concentrator will enter the normal operation status. When the oxygen concentrator is working, it will send "Clicks" sounds every few seconds, which is the normal reversing and exhaust sound.

▸ FLOWRATE

Adjust the flowmeter knob to the desired flow (the readings should be based on the black float center). Turn the flowmeter knob up to increase flow and down to decrease flow (Figure 6). **Then**, oxygen comes from the oxygen outlet.

OPERATING & INSTALLATION

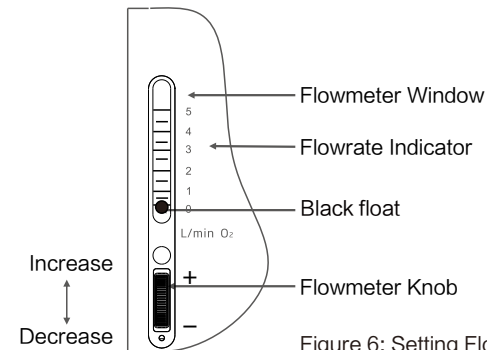

Figure 6: Setting Flowrate

Connect the firesafe valve to the oxygen outlet in the direction and position shown in Figure 7. Connect the nasal cannula to the firesafe valve, and the other end is worn with the patient, and the oxygen inhalation can be started.

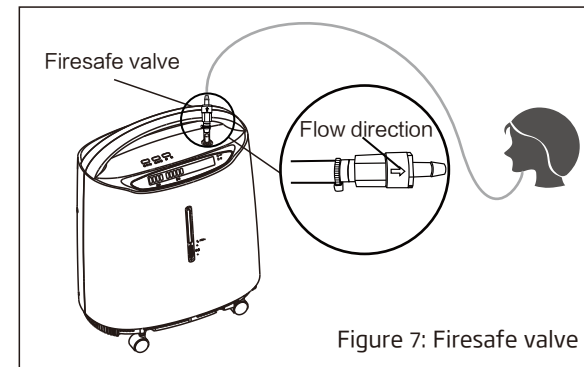

Figure 7: Firesafe valve

⚠ CAUTION: For the oxygen inhalation time and the oxygen flow adjustment, please follow the doctor's advices.

NOTE: If the flowrate on the flowmeter ever falls below 1 L/min, check for tubings or accessories that are clogged or kinked.

OPERATING & INSTALLATION

NOTE: Connect the nasal cannula to the gas outlet connector of the oxygen concentrator. With the oxygen concentrator turned on adjust the flowmeter knob to the desired flowrate. Gas should be flowing freely to the nasal cannula. You should be able to hear or feel the flow of gas to the prongs of the nasal cannula. Wave your hand in front of the prongs. If you do not feel the gas flowing, check the cannula connections for leaks.

NOTE: Recommended nasal oxygen cannula: Adult, PVC, 2m long manufactured by JIANGSU WEIKANG JIEJING MEDICALAPPARATUS CO., LTD.

IV. ALARM SIGNAL

The oxygen concentrator has the following alarm functions:

- 1) Pressure failure
- 2) Compressor failure
- 3) Low oxygen concentration
- 4) Over temperature
- 5) Low oxygen flowrate
- 6) Power supply failure
- 7) power loss
- 8) Start-up period

NOTE: All the alarms of the device are low priority.





NOTE: All the alarm conditions are technical alarm conditions.

When the oxygen concentrator starts, the blue, green and yellow indicators will be turned on and the alarm will sound once to ensure the alarm system is working properly, then the blue and yellow indicators will come off.

After 5 minutes of the oxygen concentrator starts, the oxygen sensor will work normally and will control the indicator lights depending on oxygen concentration value.

- Explanation of the indicators and symbols

OPERATING & INSTALLATION

Symbol	Status	Indicator lights	Alarm
OK	Ready for use or system is in good condition: oxygen concentration $\geq 82\%$	Green	—
	1) Oxygen concentration < minimum rated concentration (start-up period) 2) $70\% \leq$ Oxygen concentration < 82%	Yellow	Alarm
	System failure (Oxygen concentration < 70% ; Pressure failure; Compressor failure; Over temperature; Low oxygen flowrate)	Yellow	Alarm
	Power supply failure; Power loss alarm	Yellow	Alarm
	Audio alarm paused	Blue	—

- Description of the alarm conditions

1. Oxygen concentration is less than the minimum rated concentration during the start-up period. Yellow light illuminates, and the total time will be shown on the display panel. The device is in warm-up status. Wait for 3 minutes, if the alarm still persists, contact supplier immediately.
2. Oxygen concentration is greater than 82% . Green light illuminates, and panel shows total time. Normal Operation.
3. Oxygen concentration is greater than 70% and less than 82% . Yellow light illuminates, alarm sounds, and panel shows total time, contact supplier immediately.

You may continue to use the oxygen concentrator unless instructed otherwise by your supplier. Be certain that the reserve oxygen is nearby.

NOTE: Oxygen concentrator will reach to most stable state after warm-up (approximately 15 minutes).

OPERATING & INSTALLATION

- The maximum and mean delay of low oxygen concentration alarm system is 60 s.
- 4. Oxygen concentration is less than 70%. Yellow light illuminates, alarm sounds, panel shows word "LO". Please remove the power immediately, use the reserve oxygen, and contact supplier immediately.
 - The maximum and mean delay of "LO" alarm system is less than 60 s.
- 5. In case of low/high pressure failure alarm, the yellow light illuminates, alarm sounds, panel shows word "E1" or "E2", and the device shutdown. Please remove the power immediately, use the reserve oxygen, and contact supplier immediately.
 - The maximum and mean delay of "E1" alarm system is less than 10 s.
 - The maximum and mean delay of "E2" alarm system is less than 5 s.
- 6. In case of compressor failure alarm, the yellow light illuminates, alarm sounds, panel shows word "E3" or "E4", and the device shutdown. Please remove the power immediately, use the reserve oxygen, and contact supplier immediately.
 - The maximum and mean delay of compressor failure alarm system is less than 10 s.
- 7. In case of over temperature alarm, the yellow light illuminates, alarm sounds, panel shows word "E5", and the device shutdown. Please remove the power immediately, use the reserve oxygen, and contact supplier immediately.
 - The maximum and mean delay of over temperature alarm system is less than 10 s.
- 8. In case of low oxygen flowrate alarm, the yellow light illuminates, alarm sounds, panel shows word "LL", and the device shutdown. Please remove the power immediately, use the reserve oxygen, and contact supplier immediately.
 - The maximum and mean delay of low oxygen flowrate alarm system is 32 s.

OPERATING & INSTALLATION

- 9. In case of power supply failure alarm, the yellow light illuminates, alarm sounds, panel shows word "E7". Please check the power input.
 - The maximum and mean delay of power supply failure alarm system is less than 10 s.
- 10. In case of power loss alarm, the yellow light illuminates, alarm sounds, no display, and the device shutdown. Please check the power input.

▸ Audio alarm paused function

When the oxygen concentrator alarms, press the "Audio alarm paused" button, the alarm sounds will be turned off, and the blue light will be on. Press the "Audio alarm paused" button again or 2 minutes later, the alarm will sound again, and the blue light will be off.

The alarm sound pause function lasts for 2 minutes, and the oxygen concentrator will resume the alarm state after 2 minutes.

▸ Alarm limits

Alarm	Alarm limits
High pressure	Pressure is greater than 240 kPa
Low pressure	Pressure is less than 20 kPa
Compressor High current	Current is greater than 7.5 A(AC)
Compressor Low current	Current is equal to 0 A(AC)
Over temperature	Temperature of the gas around the sensor is greater than 53 °C
Low oxygen concentration	70% ≤ Oxygen concentration < 82%
LO Alarm	Oxygen concentration < 70 %
Low flow rate	Flow rate is less than 0.3 L/min
Power supply failure	Voltage is less than 90 ± 5 V(AC)
Power loss	Voltage is equal to 0 V(AC)

OPERATING & INSTALLATION

NOTE: The alarm value is detected by the sensor.

▸ Operator's position

The operator is within 1 m of the oxygen concentrator.

V. SETTING TIMING UP













This oxygen concentrator has timing function, users can set in the range of 0~2 hours.

When it start working, the display shows "TIMING ----H", witch means that the timing function is closed. It will continue to work until the power is cut off.

















Press the "⏻" button once, timing time increases 1 minute, holding the button more than 1.5 seconds it will increase continually.

The oxygen concentrator will auto turn off and the display will shows "TIMING 00:00H" when finishing timing. Reset timing function.

VI. SYMBOLS

Symbol	Description	Symbol	Description
	Alternating current		Caution
	Class II Equipment		Type BF Applied part
	OFF (power disconnection from the mains)		ON (power connection to the mains)
	Stacking Limitation		Keep Up
	Temperature limit		Humidity limitation
	No smoking		No open flame: Fire, open ignition source and smoking prohibited

OPERATING & INSTALLATION

Symbol	Description	Symbol	Description
	Keep Dry		Fragile
	Refer to instruction manual		Manufacturer
	Atmospheric pressure limitation		Date of manufacture
	Audio alarm paused		Alarm
	Standby		Time setting
	Serial number		Batch code
	U.S. Federal law restricts this device to sale by or on the order of a physician.		
	MR Unsafe: An item which poses unacceptable risks to the patient, medical staff or other persons within the MR environment.		
	Enclosures Protection Classification The first characteristic number "2": Protected against access to hazardous parts with a finger. The second characteristic number "1": Protected against vertically falling water drops.		
	The presence of this label indicates the machine was certified by ETL with the Statement: CONFORMS TO ANSI/AAMI STD ES 60601-1, IEC STD 60601-1-6, 60601-1-8, 60601-1-11, ISO STD 80601-2-69 CERTIFIED TO CSA STD C22.2 NO. 60601-1, No. 60601-1-6, No. 60601-1-8, No. 60601-1-11		

VII. TURNNING OFF

During use of the device, the user can press the "⏻" button to stop/start oxygen supply.

Take off nasal cannula from oxygen outlet first, press the power switch on the "O" position to turn off the oxygen concentrator, and then remove the power.

OPERATING & INSTALLATION

VIII. REMOTE CONTROL

Use infrared remote control to operate the device. (Figure 8)

Replace the battery of the remote control as shown in Figure 9.

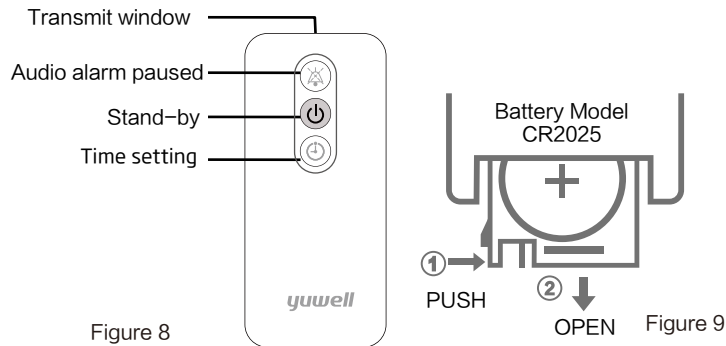

Figure 8

Figure 9

NOTE: During remote control operating, the remote control must be toward the receiver which is located in the control panel.

NOTE: The remote controller can only be used hand-held.

IX. ACCESSORIES

- The maximum oxygen flow for the accessories is not greater than 10L/min. And the maximum pressure for the accessories is not greater than 150kPa.
- This oxygen concentrator, its parts and accessories are specified for use at specific flows.
- Incompatible parts or accessories can result in degraded performance.
- The responsible organization is accountable for ensuring the compatibility of the oxygen concentrator and all of the parts or accessories used to connect to the patient before use.

⚠ WARNING: Use only water-based lotions or salves that are oxygen-compatible prior to and during oxygen therapy. Never use petroleum-

OPERATING & INSTALLATION

based or oil-based lotions or salves to avoid the risk of fire and burns.

- Firesafe valve

⚠ CAUTION: The firesafe valve is a thermal fuse designed to extinguish an oxygen delivery tube fire and stop the flow of oxygen if the tube is accidentally ignited. And the firesafe valve is flow direction-sensitive component, the install direction must correct.

⚠ CAUTION: Once the firesafe valve is actuated, it cannot be reset and must be discarded.

MAINTENANCE

⚠ CAUTION: Before maintaining the oxygen concentrator, Remove the power first to avoid electrical shock.

⚠ CAUTION: During both normal condition and single fault condition, the housing and nasal cannula can become contaminated with body fluids or expired gases. To reduce the infection risk, please perform the maintenance routinely.

NOTE: In places with high dust or soot levels, maintenance may need to be performed more often.

NOTE: After cleaning and disinfecting the oxygen concentrator, parts or accessories, please wrap them in plastic bags and store them in a dry environment until next use.

I . CLEAN CASE

⚠ CAUTION: Do not dismantle the exterior case of the oxygen concentrator.

⚠ WARNING: Liquid will damage the internal components of the oxygen concentrator and its equipment. To avoid damage or injury from electrical shock:

- Turn Off the concentrator and unplug the power cord before cleaning.
- DO NOT allow any cleaning agent to drip inside the air inlet and outlet openings.
- DO NOT spray or apply any cleaning agent directly to the cabinet.
- DO NOT hose down the product.
- DO NOT submerge the device or accessories in liquid.

▸ Clean the exterior case once a month as follows:

1) Use a cloth or sponge with a mild detergent or warm soapy water to clean the exterior case.

MAINTENANCE

2) Allow the oxygen concentrator to air dry, or use a dry towel, before operating the oxygen concentrator.

⚠ CAUTION: Before delivery to a new patient, after cleaning and before drying, it should also be disinfected as follows:

Wipe the exterior case with a cloth or sponge dipped in 70%~80% medical alcohol.

II . CLEAN OR REPLACE FILTER

Please clean or replace the filters in time, it's very important to protect compressor and to extend the oxygen concentrator life.

▸ Disassembly filter

Remove the filter cover to remove the filter screen. (Figure 10)

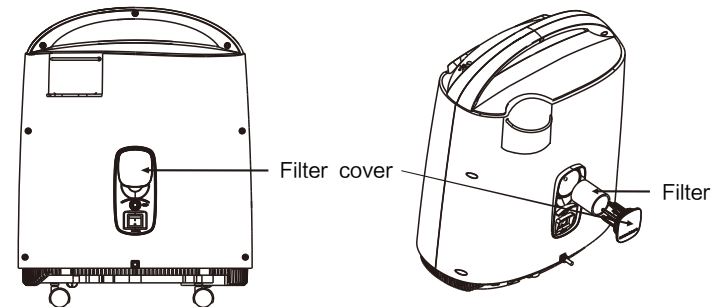

Figure 10: Remove Filter

▸ Clean the filter

- 1) Clean the filter with a mild detergent or warm soapy water and then rinse thoroughly with clean water.
- 2) DRY the filter thoroughly before reinstallation.
- 3) The filter must be cleaned or replaced once per month or as necessary.

⚠ CAUTION: Do not operate oxygen generator without filter installed or when filter is wet. These actions can permanently damage the oxygen concentrator.

MAINTENANCE

III . CLEAN FIRESAFE VALVE

▸ Clean the firesafe valve weekly as follows:

- 1) Clean the firesafe valve with a mild detergent or warm soapy water and then rinse thoroughly with clean water.
- 2) Air dry thoroughly.

⚠ **CAUTION:** Before delivery to a new patient, after cleaning and before drying, it should also be disinfected as follows:

Put the firesafe valve into 70% ~ 80% medical alcohol, cover and soak for 30 minutes for disinfection.

IV . VERIFY ALARM SYSTEM

- Verify the alarm system at least once a month: after starting the oxygen concentrator for 5 minutes, Adjust the flowmeter below 0.3 L/min, after about 30 seconds, the yellow light illuminates, alarm sounds, panel shows word "LL", and the device shutdown. Press the "Audio alarm Paused" button, the alarm will be turned off, and the blue light will be on. Press the "Audio alarm Paused" button again, the alarm will sound again, and the blue light will be off.
- Methods to check the function of the alarm system for each of the alarm conditions are specified in the Technical Manual (Document No.:YY-OXG8510D-03).

V . INSTRUCTIONS FOR PROCESSING AND REPROCESSING

- In order to prevent injury caused by infection or damage to the oxygen concentrator, only qualified personnel can clean and disinfect the oxygen concentrator and its accessories for multiple patients.
- Follow the instructions below to eliminate possible pathogen infection between patients caused by component or accessory contamination. If necessary, preventive maintenance should also be carried out at

MAINTENANCE

this time.

- 1) Processing or replace the nasal cannula.
- 2) Check whether the appearance of the oxygen concentrator is damaged or needs to be repaired.
- 3) Perform all procedures in the Maintenance section.
- 4) Ensure that the oxygen concentrator functions normally and all alarms are in normal working condition.
- 5) Before delivering to a new patient, ensure that the delivery includes the oxygen concentrator and this manual.

TROUBLESHOOTING

Use the table below to take actions when the oxygen concentrator indicates an abnormal condition.

Symptom	Probable cause	Solution
The oxygen concentrator is not working, the yellow light illuminates, alarm sounds, no display.	1) Poor contact between power cord plug and socket.	1) Insert the power cord plug firmly into the socket.
	2) The socket has no power output.	2) Move to a socket with power output.
	3) Insufficient power at the power outlet of the socket.	3) Do not use extension cords. Move the oxygen concentrator to another power outlet.
	4) Breaker reset button raised.	4) Press down the breaker reset button.
	5) If the oxygen concentrator still does not work, please contact the supplier.	
The oxygen concentrator is working and the operating sound is normal, the flowrate can be adjusted but no oxygen output or weak output.	1) The accessory (nasal cannula, mask..., etc.) is leaking.	1) Replace the leaked accessory.
	2) If the phenomenon is still appeared, please contact the supplier.	
The oxygen concentrator is working, but the yellow light illuminates, alarm sounds.	1) $70\% \leq$ Oxygen concentration $< 82\%$	1) Clean or replace the filter.
	2) Oxygen flowrate over the maximum recommend flowrate: 5 L/min.	2) Adjust the flowrate only under the advice of the doctor.
	3) If the phenomenon is still appeared, the device can be used but please contact the supplier.	

TROUBLESHOOTING

Symptom	Probable cause	Solution
The oxygen concentrator is working, the yellow light illuminates, alarm sounds, panel shows word "LO".	1) Oxygen concentration $< 70\%$	1) Clean or replace the filter.
	2) Oxygen flowrate over the maximum recommend flowrate: 5 L/min.	2) Adjust the flowrate only under the advice of the doctor.
	3) If the phenomenon is still appeared, stop using the device, please contact the supplier immediately.	
The oxygen concentrator is not working, the yellow light illuminates, alarm sounds, panel shows word "E1".	1) The system pressure is too low.	1) Clean or replace the filter.
	2) If the phenomenon is still appeared, stop using the device, please contact the supplier immediately.	
The oxygen concentrator is not working, the yellow light illuminates, alarm sounds, panel shows word "E2".	The system pressure is too high.	Stop using the device, please contact the supplier immediately.
The oxygen concentrator is not working, the yellow light illuminates, alarm sounds, panel shows word "E3".	The compressor circuit is open.	Stop using the device, please contact the supplier immediately.
The oxygen concentrator is not working, the yellow light illuminates, alarm sounds, panel shows word "E4".	The compressor circuit is short-circuited.	Stop using the device, please contact the supplier immediately.

TROUBLESHOOTING

Symptom	Probable cause	Solution
The oxygen concentrator is not working, the yellow light illuminates, alarm sounds, panel shows word "E5".	1) The temperature inside the oxygen concentrator is too high.	2) Stop using the device, please contact the supplier immediately.
The oxygen concentrator is working, but the yellow light illuminates, alarm sounds, panel shows word "E7".	1) Power voltage is lower.	1) Change power source to meet the normal voltage condition.
	2) Stop using the device, please contact the supplier immediately.	
The oxygen concentrator is not working, the yellow light illuminates, alarm sounds, panel shows word "LL".	1) Oxygen flowrate is too low.	1) Turn the flowmeter knob counterclockwise to increase flow.
	2) If the phenomenon is still appeared, stop using the device, please contact the supplier immediately.	
Remote control malfunction.	1) The remote control was not used in the receiving area.	1) Use the remote control in front of the oxygen concentrator.
	2) The battery power of the remote control is low.	2) Replace the battery in the remote control.

⚠ CAUTION: If you have any other problems, TURN OFF the concentrator first, use your reserve oxygen supply, and contact the supplier immediately.

⚠ CAUTION: Steps of disassembling the oxygen concentrator(only for service personnel) are specified in the Technical Manual (Document No.:YY-OXG8510D-03).

OTHER ATTENTION ITEMS

I . GAS PASS OPERATION SKETCH MAP

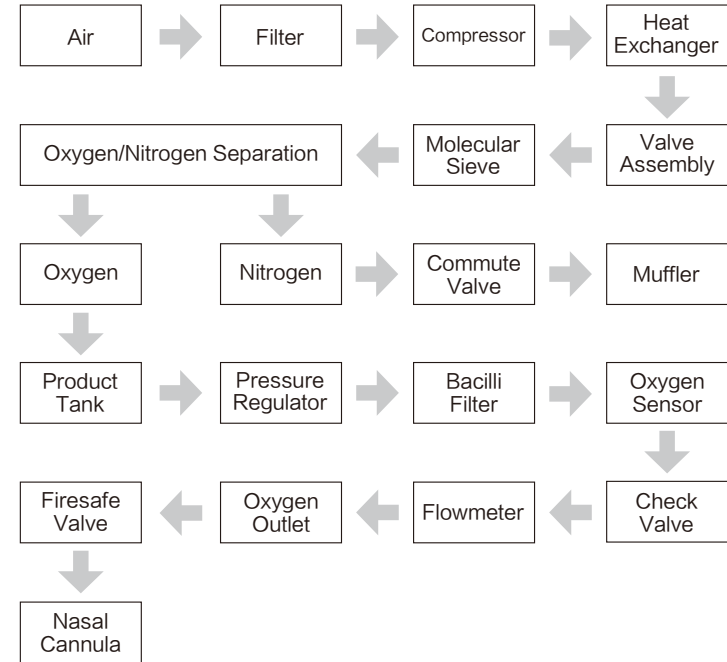

II . ELECTRICAL RATIONALE

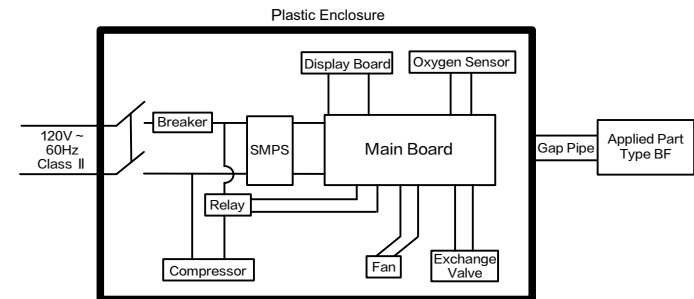

OTHER ATTENTION ITEMS

III . PACKING LIST

1. Oxygen Concentrator	1 unit
2. User Manual	1 piece
3. Firesafe Valve	1 piece
4. Remote Controller	1 piece

▶ Information for accessories

Name	Manufacturer	Type	Technical data
Firesafe Valve	JIANGSU YUYUE MEDICAL EQUIPMENT & SUPPLY CO., LTD	YY-ZYJ-TY-10-00	ABS, external diameter of connector : ϕ 7mm

IV . DEVICE DISPOSAL

The lay responsible organization must contact its local authorities to determine the proper method of disposal of the oxygen concentrator and accessories.

Particular attention shall be given to the disposal of the molecular sieves.

EMC INFORMATION

- ⚠ **WARNING:** Far away from HF SURGICAL EQUIPMENT and the RF shielded room of an ME SYSTEM for magnetic resonance imaging in hospitals, where the intensity of EM DISTURBANCES is high.
- ⚠ **WARNING:** Use of this equipment adjacent to or stacked with other equipment should be avoided because it could result in improper operation. If such use is necessary, this equipment and the other equipment should be observed to verify that they are operating normally.
- ⚠ **WARNING:** Use of accessories, transducers and cables other than those specified or provided by the manufacturer of this equipment could result in increased electromagnetic emissions or decreased electromagnetic immunity of this equipment and result in improper operation.
- ⚠ **WARNING:** Portable RF communications equipment (including peripherals such as antenna cables and external antennas) should be used no closer than 30 cm (12 inches) to any part of the 8F-5A oxygen concentrator, including cables specified by the manufacturer. Otherwise, degradation of the performance of this equipment could result.

ESSENTIAL PERFORMANCE: The oxygen concentration in the delivered gas, in both normal condition and single fault condition, within the performance levels as indicated in the instructions for use, or generation of an alarm condition: power supply failure technical alarm condition, low oxygen concentration technical alarm condition, malfunction technical alarm condition, start-up period technical alarm condition.
- ⚠ **CAUTION:** If the oxygen concentrator is not working normally or an alarm condition occurs, the user should attempt to move the oxygen concentrator to a different area to determine if the issue is due to electromagnetic interference with other equipment in the vicinity.

EMC INFORMATION

Table 1: Guidance and declaration of manufacturer – electromagnetic immunity.

Phenomenon	Basic EMC standard or test method	Immunity test levels
ELECTROSTATIC DISCHARGE	IEC 61000-4-2	± 8 kV contact ± 2 kV, ± 4 kV, ± 8 kV, ± 15 kV air
Radiated RF EM fields	IEC 61000-4-3	10 V/m 80 MHz – 2.7 GHz 80% AM at 1 kHz
RATED power frequency magnetic fields	IEC 61000-4-8	30 A/m 50 Hz or 60 Hz
Electrical fast transients / bursts	IEC 61000-4-4	± 2 kV 100 kHz repetition frequency
Surges Line-to-line	IEC 61000-4-5	± 0.5 kV, ± 1 kV
Conducted disturbances induced by RF fields	IEC 61000-4-6	3 V/m 0.15 MHz – 80 MHz 6V in ISM and amateur radio bands between 0.15 MHz and 80 MHz 80% AM at 1 kHz
Voltage dips	IEC 61000-4-11	0% U _T ; 0.5 cycle At 0°, 45°, 90°, 135°, 180°, 225°, 270° and 315°
		0% U _T ; 1 cycle and 70% U _T ; 25/30 cycles Single phase: at 0°
Voltage interruptions	IEC 61000-4-11	0% U _T ; 250/300 cycles

EMC INFORMATION

Table 2: Test specifications for ENCLOSURE PORT IMMUNITY to RF wireless communications equipment

Test frequency (MHZ)	Band (MHZ)	Service	Modulation	IMMUNITY TEST LEVEL (V/m)
385	380 to 390	TETRA 400	Pulse modulation 18 Hz	27
450	430 to 470	GMRS 460, FRS 460	FM ± 5 kHz deviation 1 kHz sine	28
710	704 to 787	LTE Band 13,17	Pulse modulation 217 Hz	9
745				
780				
810	800 to 960	GSM 800/900, TETRA 800, iDEN 820, CDMA 850, LTE Band 5	Pulse modulation 18 Hz	28
870				
930				
1720	1700 to 1990	GSM 1800; CDMA 1900; GSM 1900; DECT; LTE Band 1, 3, 4, 25; UMTS	Pulse modulation 217 Hz	28
1845				
1970				
2450	2400 to 2570	Bluetooth, WLAN, 802.11 b/g/n, RFID 2450, LTE Band 7	Pulse modulation 217 Hz	28
5240	5100 to 5800	WLAN 802.11 a/n	Pulse modulation 217 Hz	9
5500				
5785				

NOTE: If necessary to achieve the IMMUNITY TEST LEVEL, the distance between the transmitting antenna and the ME EQUIPMENT or ME SYSTEM may be reduced to 1 m. The 1 m test distance is permitted by IEC 61000-4-3.

EMC INFORMATION

Table 3: Guidance and declaration of manufacturer – electromagnetic emission

Phenomenon	Compliance
Conducted and radiated RF EMISSIONS CISPR 11	Group 1, Class B
Harmonic distortion IEC 61000-3-2	Class A
Voltage fluctuations and flicker IEC 61000-3-3	Complies